

VIEW	TOLERANCE	
	0-10	±1
	11-250	±5
	251-500	±10
	501-1000	±20
	1001-3000	±50
UNIT: mm	3001-5000	±100
	5001- >	±150

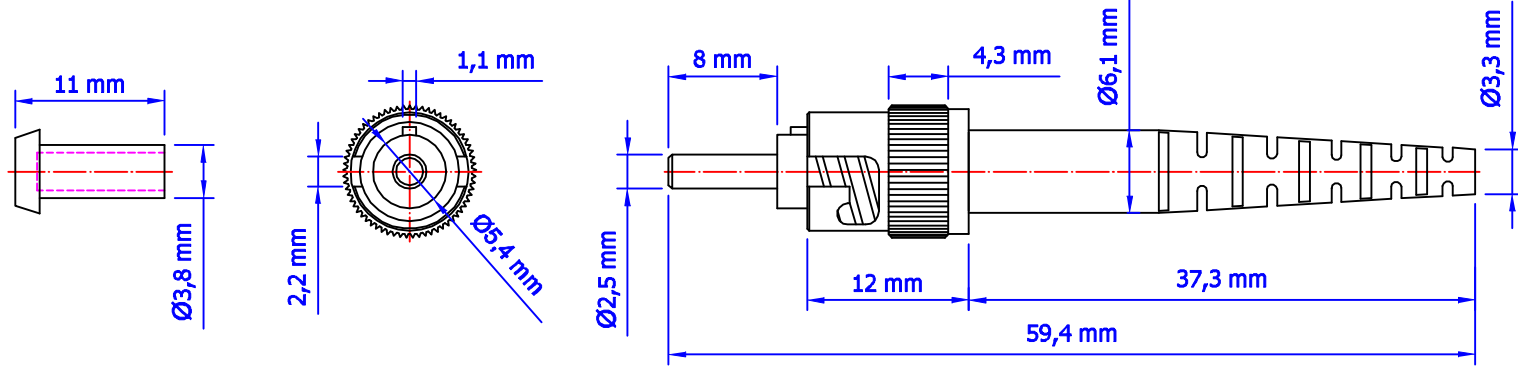

Date	16.03.2016	Rev.		Revision Detail	Rev.Dt.	Rev.by	Part No		
Designed by	Yeşim AKSOY	-					ST/PC SM SX CONNECTOR		
Checked by	Mevlüt GÜRBÜZ								
							Drawing Nr.	Scale	Sheet No
							FO-0301SMP482	NONE	1/1